



BESPOKUS

EPDM and GRASS

3D FIGURES



**PLAY AND LEISURE
SOLUTIONS**

EPDM



- ✓ Durable
- ✓ Flame-retardant
- ✓ Weatherproof
- ✓ Eco-friendly and harmless to health
- ✓ Virgin material
- ✓ Inexpensive to look after and maintain
- ✓ Sensible use of resources in the long term

► Product information

Property	Unit	Value*	Test standards
Density	g/cm ³	1.60	DIN EN 1183-1
Polymer content	%	approx. 20	DIN EN ISO 3451-1
Hardness	Shore A	60	DIN ISO 7619-1
Tensile strength	MPa	> 6	DIN 53 504
Elongation at break	%	> 700	DIN 53 504
Grain size	mm	0.0 - 0.5 0.5 - 1.5 1.0 - 2.0 1.0 - 2.5 and 1.0 - 3.5 (other grain sizes on request)	
Polymer base	EPDM		
Flame retardance	Flame-retardant material compliant with class C _f -s1 (DIN EN 13501-1) available		

BINDER is designed specifically for bonding rubber granules and other rubber products for use in the installation of children's playgrounds, sports surfaces and other applications.



EGG 20P



YC 20P



TIERRA 20P

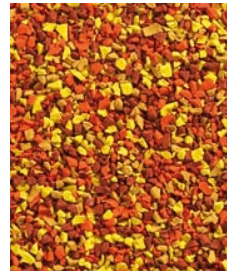

FUEGO 20P



OG 20P



YT 20P



PBR 20P



PK 20P



BGE 20P



R 30S



BN 20P



GDY 20P

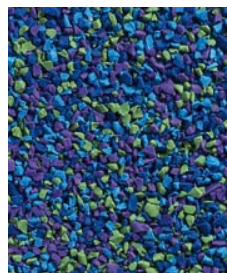

AGUA 20P

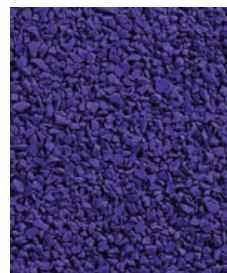

PL 20P



BSL 30S



BLL 20P



TEAL 20P



GLN 30S



GN 30S

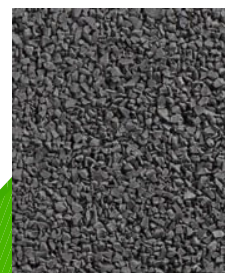

GMY 20P

Custom Mix Colours are Available !!



RA 001

BESPOKUS

SECURITY AREA 24,5m²

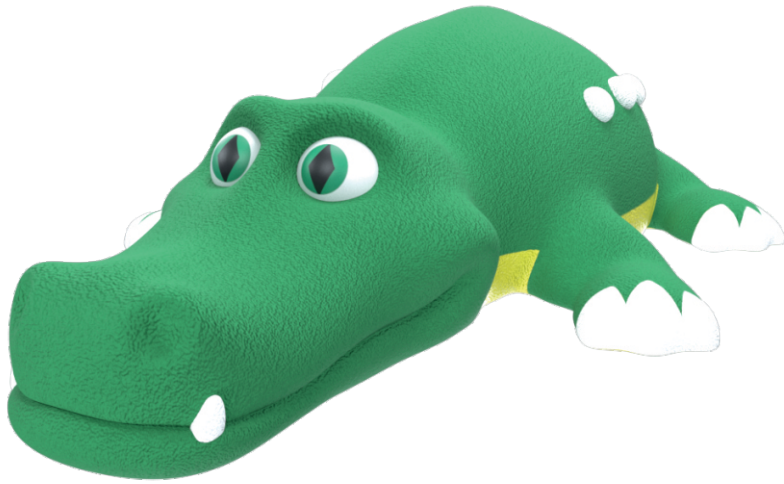

3,5m

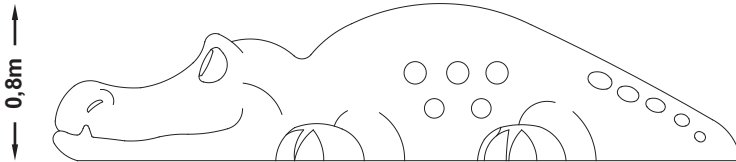

0,8m

FRONT VIEW

6,5m

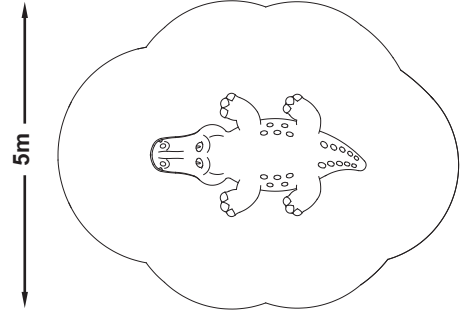

5m

TOP VIEW

2m

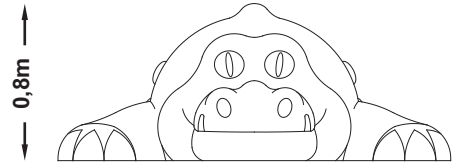

0,8m

SIDE VIEW





RA 002

BESPOKUS

SECURITY AREA 24,5m²

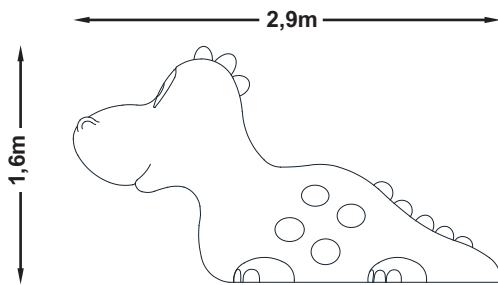

FRONT VIEW

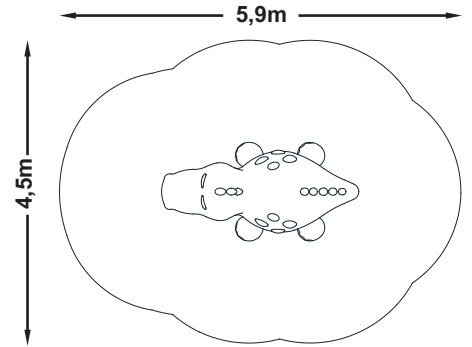

TOP VIEW

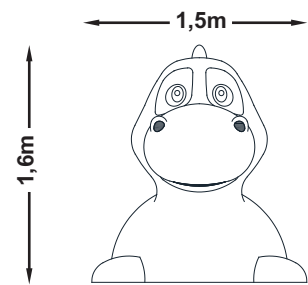

SIDE VIEW





RA 003



SECURITY AREA 19,6m²

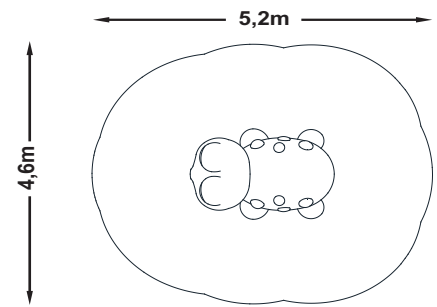

TOP VIEW

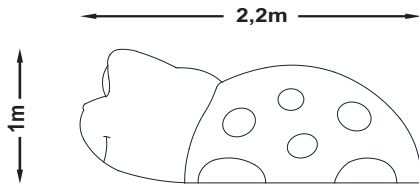

FRONT VIEW

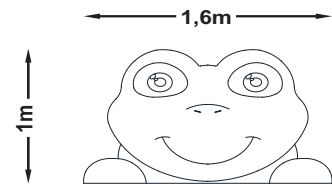

SIDE VIEW





RA 004

BESPOKUS

SECURITY AREA 18,7m²

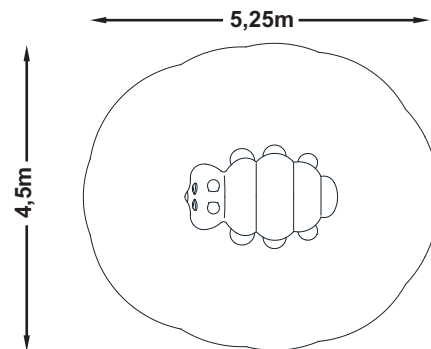

TOP VIEW

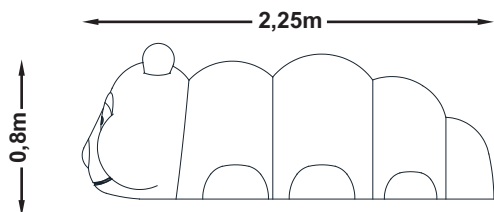

FRONT VIEW

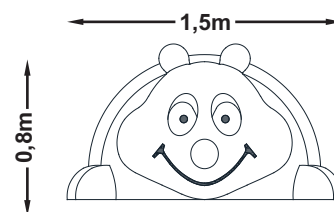

SIDE VIEW





RA 005

BESPOKUS

SECURITY AREA 19,9m²

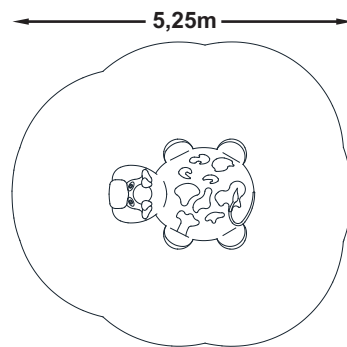

TOP VIEW

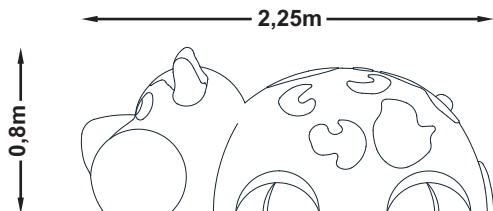

FRONT VIEW

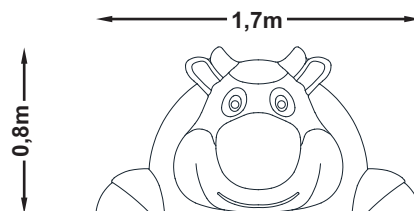

SIDE VIEW

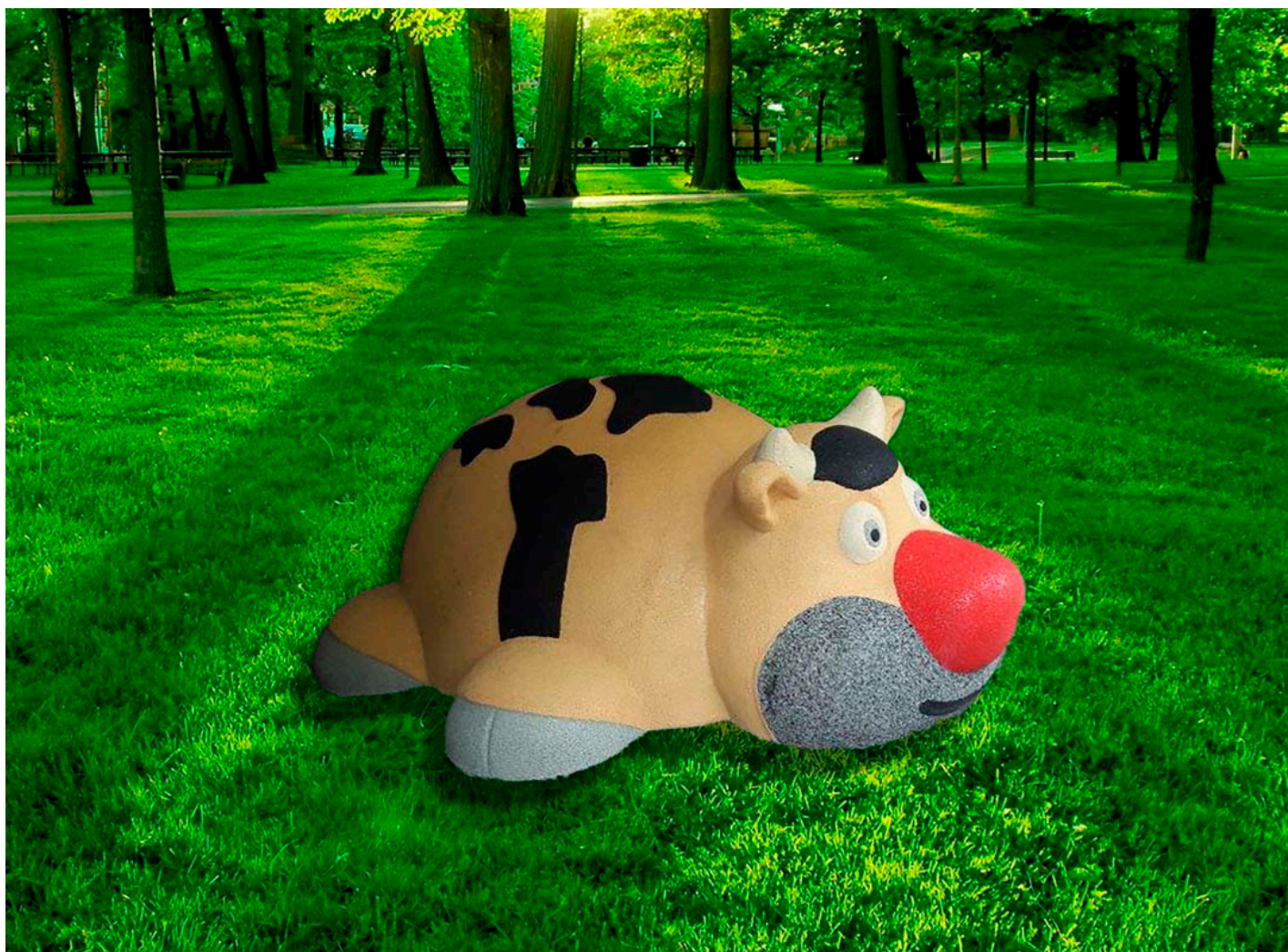



RA 006

BESPOKUS

SECURITY AREA 24,5m²

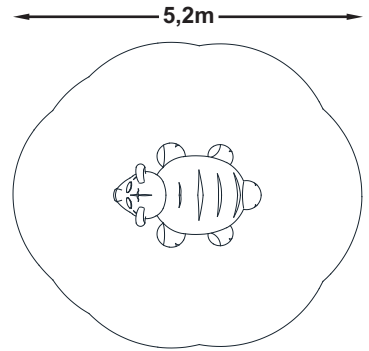

TOP WIEW

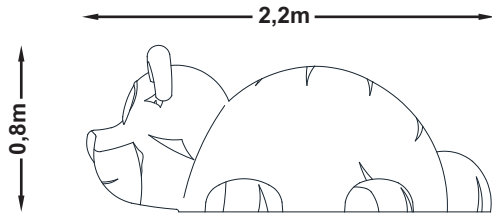

FRONT WIEW

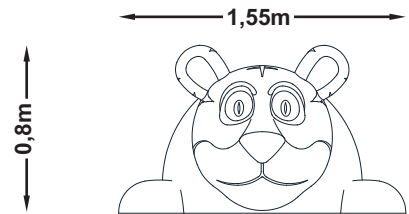

SIDE WIEW





RA 007

BESPOKUS

SECURITY AREA 20,2m²

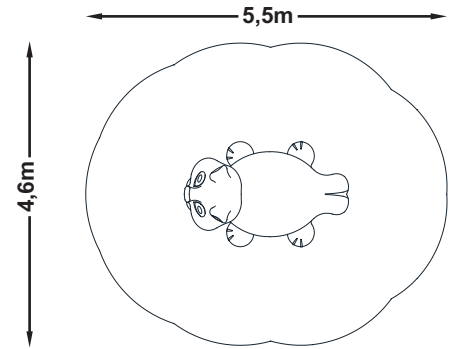
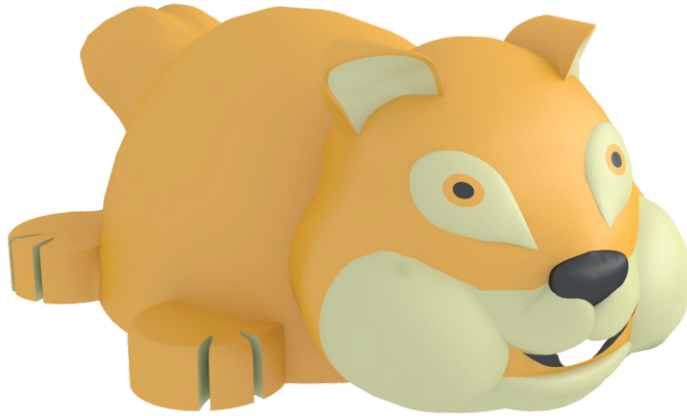

TOP VIEW

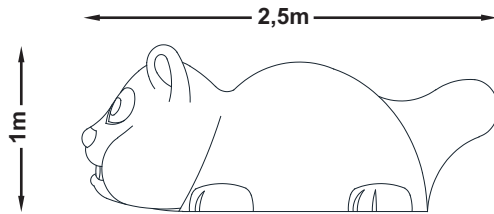

FRONT VIEW

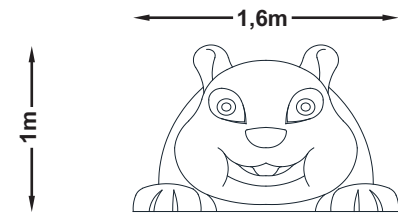

SIDE VIEW





RA 008

BESPOKUS

SECURITY AREA 19m²



5,25m

4,65m

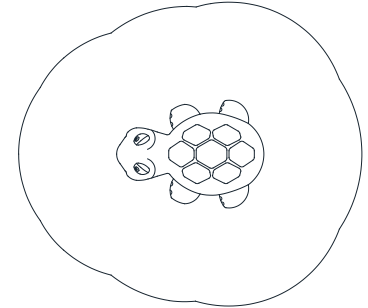

TOP VIEW

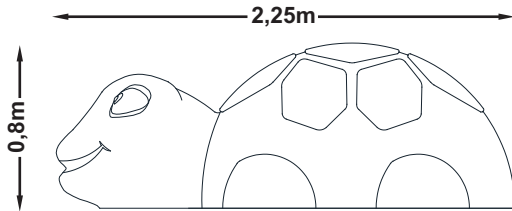

FRONT VIEW

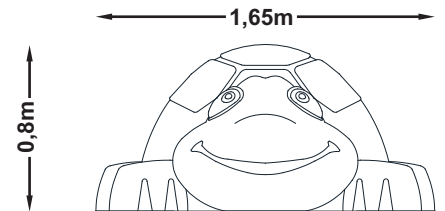

SIDE VIEW





BESPOKUS

RA 009-1 MINI

SECURITY AREA 10,7m²

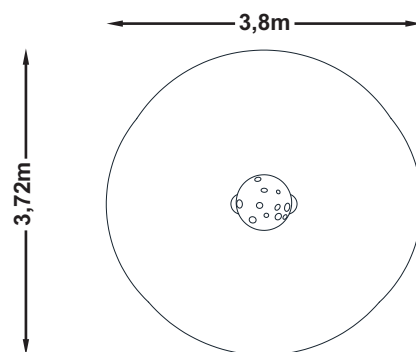

TOP WIEW

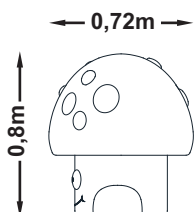

FRONT WIEW

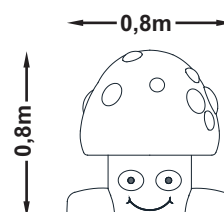

SIDE WIEW

RA 009-2 MIDI

SECURITY AREA 13,2m²

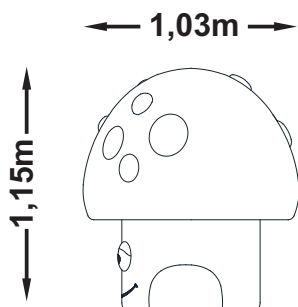

FRONT WIEW

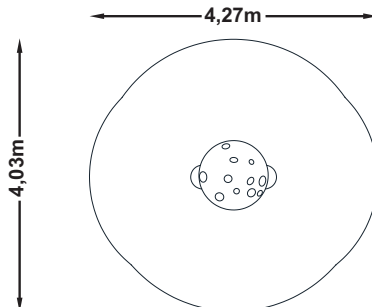

TOP WIEW

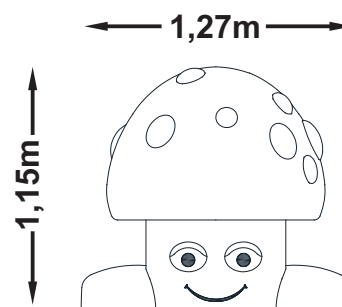

SIDE WIEW

RA 009-3 MAXI

SECURITY AREA 13,5m²

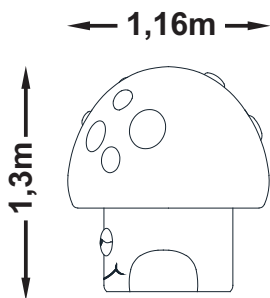

FRONT WIEW

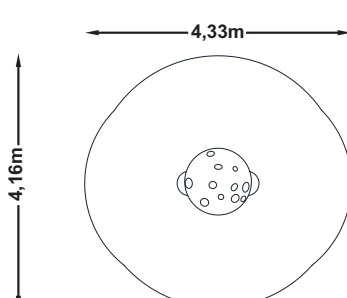

TOP WIEW

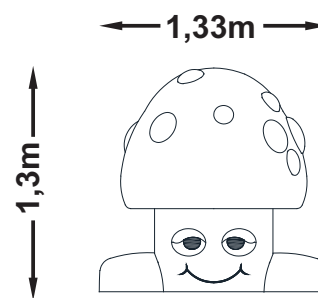

SIDE WIEW

NIGHT MODE ON !!



Avatar Stones (tm) may be applied on request for night illumination.

